

# HM169-5

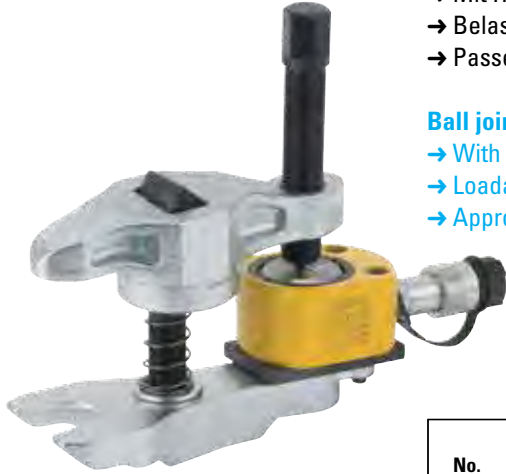



**Gelenkbolzen-Ausdrücker für schwere LKW und Busse**

- Mit Hydraulikzylinder für höhere Leistung
- Belastbar bis 20 t
- Passend für Gelenkbolzen 35–45 mm Durchmesser

**Ball joint extractor for heavy trucks and buses**

- With oil-hydraulic-cylinder for more power
- Loadable up to 20 t
- Appropriate for joint pins with diameter 35–45 mm

No.		Gabelöffnung fork diameter mm	lichte Höhe vertical clearance mm		
HM169-5	●	45	max. 115	Ausdrücker mit Hydraulikzylinder Nr. HZ-10 Extractor with hydrauliccylinder No. HZ-10	7,6
H0169-5	●	45	max. 115	Ausdrücker ohne Hydraulikzylinder Extractor without hydrauliccylinder	6,0
HZ-10	●			10 t Zylinder für Handpumpen 10 t cylinder for hand pumps	1,6
HZ-20	●			20 t Zylinder für Handpumpen 20 t cylinder for hand pumps	2,8

# 182









**Lenkrad-Abzieher, 3-armig mit Zugring**

- Geeignet für Lenkräder mit 3 oder 4 Speichen
- Der Zugring ist zum Schutz der Lenkräder mit verschiebbaren Gummihülsen ausgestattet

**Steering-wheel puller, 3-arms with pulling ring**

- Suitable for steering wheels with 3 or 4 spokes
- To protect the steering wheels the pulling ring is equipped with sliding rubber sleeves

No.							
182	160	120	70	4	M14x1,5x130	17	1,9